

# Inspiron 14/14R

## Owner's Manual

Computer model: Inspiron 3421/5421  
Regulatory model: P37G  
Regulatory type: P37G001



# Notes, Cautions, and Warnings



**NOTE:** A NOTE indicates important information that helps you make better use of your computer.



**CAUTION:** A CAUTION indicates potential damage to hardware or loss of data if instructions are not followed.



**WARNING:** A WARNING indicates a potential for property damage, personal injury, or death.

---

© 2012 Dell Inc.

Trademarks used in this text: Dell™, the DELL logo, and Inspiron™ are trademarks of Dell Inc.; Microsoft®, Windows®, and the Windows start button logo are either trademarks or registered trademarks of Microsoft Corporation in the United States and/or other countries; Bluetooth® is a registered trademark owned by Bluetooth SIG, Inc. and is used by Dell under license.

# Contents

<b>Before You Begin</b> . . . . .	<b>9</b>
Turn Off Your Computer and Connected Devices. . . . .	9
Safety Instructions. . . . .	10
Recommended Tools. . . . .	10
<b>After Working Inside Your Computer</b> . . . . .	<b>11</b>
<b>Removing the Battery</b> . . . . .	<b>12</b>
Procedure . . . . .	12
<b>Replacing the Battery</b> . . . . .	<b>13</b>
Procedure . . . . .	13
<b>Removing the Optical Drive</b> . . . . .	<b>14</b>
Prerequisites. . . . .	14
Procedure . . . . .	14
<b>Replacing the Optical Drive</b> . . . . .	<b>16</b>
Procedure . . . . .	16
Postrequisites. . . . .	16
<b>Removing the Keyboard</b> . . . . .	<b>17</b>
Prerequisites. . . . .	17
Procedure . . . . .	17
<b>Replacing the Keyboard</b> . . . . .	<b>20</b>
Procedure . . . . .	20
Postrequisites. . . . .	20
<b>Removing the Base Cover</b> . . . . .	<b>21</b>
Prerequisites. . . . .	21
Procedure . . . . .	21

<b>Replacing the Base Cover</b> . . . . .	<b>22</b>
Procedure . . . . .	22
Postrequisites. . . . .	22
<b>Removing the Memory Module(s)</b> . . . . .	<b>23</b>
Prerequisites. . . . .	23
Procedure . . . . .	23
<b>Replacing the Memory Module(s)</b> . . . . .	<b>24</b>
Procedure . . . . .	24
Postrequisites. . . . .	24
<b>Removing the Hard Drive</b> . . . . .	<b>25</b>
Prerequisites. . . . .	25
Procedure . . . . .	25
<b>Replacing the Hard Drive</b> . . . . .	<b>27</b>
Procedure . . . . .	27
Postrequisites. . . . .	27
<b>Removing the Wireless Mini-Card</b> . . . . .	<b>28</b>
Prerequisites. . . . .	28
Procedure . . . . .	28
<b>Replacing the Wireless Mini-Card</b> . . . . .	<b>30</b>
Procedure . . . . .	30
Postrequisites. . . . .	30
<b>Removing the Palm-Rest</b> . . . . .	<b>31</b>
Prerequisites. . . . .	31
Procedure . . . . .	31
<b>Replacing the Palm-Rest</b> . . . . .	<b>35</b>
Procedure . . . . .	35
Postrequisites. . . . .	35

<b>Removing the Coin-Cell Battery</b> . . . . .	<b>36</b>
Prerequisites. . . . .	36
Procedure . . . . .	37
<b>Replacing the Coin-Cell Battery</b> . . . . .	<b>38</b>
Procedure . . . . .	38
Postrequisites. . . . .	38
<b>Removing the I/O Board</b> . . . . .	<b>39</b>
Prerequisites. . . . .	39
Procedure . . . . .	40
<b>Replacing the I/O Board</b> . . . . .	<b>41</b>
Procedure . . . . .	41
Postrequisites. . . . .	41
<b>Removing the Power-Adapter Port</b> . . . . .	<b>42</b>
Prerequisites. . . . .	42
Procedure . . . . .	43
<b>Replacing the Power-Adapter Port</b> . . . . .	<b>45</b>
Procedure . . . . .	45
Postrequisites. . . . .	45
<b>Removing the System Board</b> . . . . .	<b>46</b>
Prerequisites. . . . .	46
Procedure . . . . .	47
<b>Replacing the System Board</b> . . . . .	<b>49</b>
Procedure . . . . .	49
Postrequisites. . . . .	49
Entering the Service Tag in system setup. . . . .	50
<b>Removing the Thermal-Cooling Assembly</b> . . . . .	<b>51</b>
Prerequisites. . . . .	51
Procedure . . . . .	51

<b>Replacing the Thermal-Cooling Assembly . . . . .</b>	<b>52</b>
Procedure . . . . .	52
Postrequisites. . . . .	52
<b>Removing the Speakers . . . . .</b>	<b>53</b>
Prerequisites. . . . .	53
Procedure . . . . .	54
<b>Replacing the Speakers . . . . .</b>	<b>55</b>
Procedure . . . . .	55
Postrequisites. . . . .	55
<b>Removing the Display Assembly . . . . .</b>	<b>56</b>
Prerequisites. . . . .	56
Procedure . . . . .	57
<b>Replacing the Display Assembly . . . . .</b>	<b>58</b>
Procedure . . . . .	58
Postrequisites. . . . .	58
<b>Removing the Display Bezel . . . . .</b>	<b>59</b>
Prerequisites. . . . .	59
Procedure . . . . .	60
<b>Replacing the Display Bezel . . . . .</b>	<b>61</b>
Procedure . . . . .	61
Postrequisites. . . . .	61
<b>Removing the Display Hinges . . . . .</b>	<b>62</b>
Prerequisites. . . . .	62
Procedure . . . . .	63
<b>Replacing the Display Hinges . . . . .</b>	<b>64</b>
Procedure . . . . .	64
Postrequisites. . . . .	64

<b>Removing the Display Panel</b> . . . . .	<b>65</b>
Prerequisites. . . . .	65
Procedure . . . . .	66
<b>Replacing the Display Panel</b> . . . . .	<b>67</b>
Procedure . . . . .	67
Postrequisites. . . . .	67
<b>Removing the Camera Module</b> . . . . .	<b>68</b>
Prerequisites. . . . .	68
Procedure . . . . .	69
<b>Replacing the Camera Module</b> . . . . .	<b>70</b>
Procedure . . . . .	70
Postrequisites. . . . .	70
<b>Flashing the BIOS</b> . . . . .	<b>71</b>







# Before You Begin

---

## Turn Off Your Computer and Connected Devices

 **CAUTION:** To avoid losing data, save and close all open files and exit all open programs before you turn off your computer.

- 1 Save and close all open files and exit all open programs.
- 2 Shut down your computer.
  - *Windows 8:*
    - a Point your mouse pointer to the upper-right or lower-right corner of the screen to open the Charms sidebar.
    - b In the Charms sidebar, click **Settings**→ **Power**→ **Shut down**.
  - *Windows 7:*  
Click **Start**  and click **Shut down**.









Microsoft Windows shuts down and then the computer turns off.

 **NOTE:** If you are using a different operating system, see the documentation of your operating system for shut-down instructions.

- 3 Disconnect your computer and all attached devices from their electrical outlets.
- 4 Disconnect all telephone cables, network cables, and attached devices from your computer.
- 5 After you unplug all the cables from the computer, press and hold the power button for 5 seconds to ground the system board.

# Safety Instructions

Use the following safety guidelines to protect your computer from potential damage and ensure your personal safety.

-  **WARNING:** Before working inside your computer, read the safety information that shipped with your computer. For additional safety best practices information, see the Regulatory Compliance Homepage at [dell.com/regulatory\\_compliance](http://dell.com/regulatory_compliance).
-  **WARNING:** Disconnect all power sources before opening the computer cover or panels. After you finish working inside the computer, replace all covers, panels, and screws before connecting to the power source.
-  **CAUTION:** To avoid damaging the computer, ensure that the work surface is flat and clean.
-  **CAUTION:** To avoid damaging the components and cards, handle them by their edges and avoid touching pins and contacts.
-  **CAUTION:** Only a certified service technician is authorized to remove the computer cover and access any of the components inside the computer. See the safety instructions for complete information about safety precautions, working inside your computer, and protecting against electrostatic discharge.
-  **CAUTION:** Before touching anything inside your computer, ground yourself by touching an unpainted metal surface, such as the metal at the back of the computer. While you work, periodically touch an unpainted metal surface to dissipate static electricity, which could harm internal components.
-  **CAUTION:** When you disconnect a cable, pull on its connector or on its pull-tab, not on the cable itself. Some cables have connectors with locking tabs or thumb-screws that you must disengage before disconnecting the cable. When disconnecting cables, keep them evenly aligned to avoid bending any connector pins. When connecting cables, ensure that the connectors and ports are correctly oriented and aligned.
-  **CAUTION:** To disconnect a network cable, first unplug the cable from your computer and then unplug the cable from the network device.
-  **CAUTION:** Press and eject any installed card from the media-card reader.

## Recommended Tools

The procedures in this document may require the following tools:

- Phillips screwdriver
- Plastic scribe

# After Working Inside Your Computer

---

After you complete the replacement procedures, ensure the following:

- Replace all screws and ensure that no stray screws remain inside your computer.
- Connect any external devices, cables, cards, and any other part(s) you removed before working on your computer.
- Connect your computer and all attached devices to their electrical outlets.



**CAUTION: Before turning on your computer, replace all screws and ensure that no stray screws remain inside the computer. Failure to do so may damage your computer.**

# Removing the Battery

---

**⚠ WARNING:** Before working inside your computer, read the safety information that shipped with your computer and follow the steps in "Before You Begin" on page 9. After working inside your computer, follow the instructions in "After Working Inside Your Computer" on page 11. For additional safety best practices information, see the Regulatory Compliance Homepage at [dell.com/regulatory\\_compliance](http://dell.com/regulatory_compliance).

## Procedure

- 1 Close the display and turn the computer over.
- 2 Slide the battery latches to the unlock position. You hear a click when the battery is unlocked.
- 3 Lift and remove the battery off the computer base.

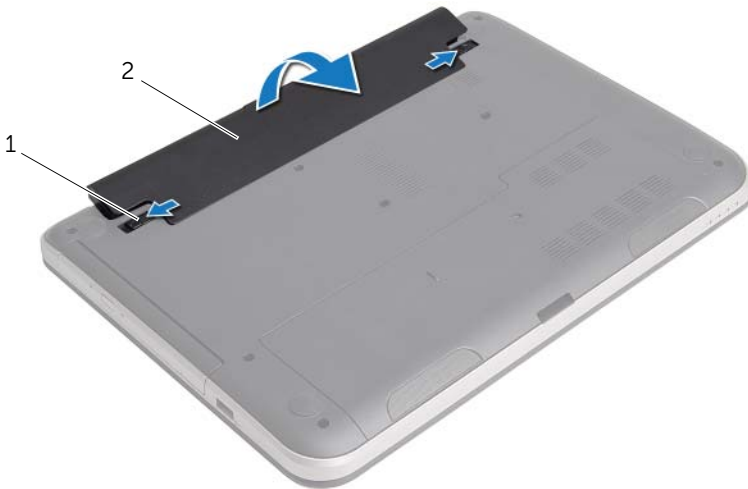

---

1 battery latches (2)

2 battery

---

# Replacing the Battery

---



**WARNING:** Before working inside your computer, read the safety information that shipped with your computer and follow the steps in "Before You Begin" on page 9. After working inside your computer, follow the instructions in "After Working Inside Your Computer" on page 11. For additional safety best practices information, see the Regulatory Compliance Homepage at [dell.com/regulatory\\_compliance](http://dell.com/regulatory_compliance).

## Procedure

Align the tabs on the battery with the slots on the battery bay and snap the battery into place.

# Removing the Optical Drive

---

**⚠ WARNING:** Before working inside your computer, read the safety information that shipped with your computer and follow the steps in "Before You Begin" on page 9. After working inside your computer, follow the instructions in "After Working Inside Your Computer" on page 11. For additional safety best practices information, see the Regulatory Compliance Homepage at [dell.com/regulatory\\_compliance](http://dell.com/regulatory_compliance).

## Prerequisites

Remove the battery. See "Removing the Battery" on page 12.

## Procedure

- 1 Remove the screw that secures the optical-drive assembly to the computer base.
- 2 Using your fingertips, slide the optical-drive assembly out of the optical-drive bay.



---

1 optical-drive assembly

2 screw

---

- 3 Remove the screw that secures the optical-drive bracket to the optical-drive assembly and remove the optical-drive bracket.

4 Carefully pull the optical-drive bezel and remove it from the optical drive.

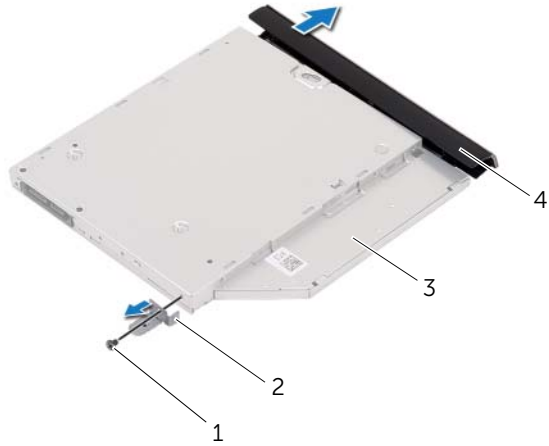

1	screw	2	optical-drive bracket
3	optical drive	4	optical-drive bezel

# Replacing the Optical Drive

---



**WARNING:** Before working inside your computer, read the safety information that shipped with your computer and follow the steps in "Before You Begin" on page 9. After working inside your computer, follow the instructions in "After Working Inside Your Computer" on page 11. For additional safety best practices information, see the Regulatory Compliance Homepage at [dell.com/regulatory\\_compliance](http://dell.com/regulatory_compliance).

## Procedure

- 1 Align the tabs on the optical-drive bezel with the slots on the optical drive and snap the optical-drive bezel into place.
- 2 Align the screw hole on the optical-drive bracket with the screw hole on the optical-drive assembly and replace the screw that secures the optical-drive bracket to the optical-drive assembly.
- 3 Slide the optical-drive assembly into the optical-drive bay and ensure that the screw hole on the optical-drive bracket aligns with the screw hole on computer base.
- 4 Replace the screw that secures the optical-drive assembly to the computer base.

## Postrequisites

Replace the battery. See "Replacing the Battery" on page 13.



# Removing the Keyboard

---

**⚠ WARNING:** Before working inside your computer, read the safety information that shipped with your computer and follow the steps in "Before You Begin" on page 9. After working inside your computer, follow the instructions in "After Working Inside Your Computer" on page 11. For additional safety best practices information, see the Regulatory Compliance Homepage at [dell.com/regulatory\\_compliance](http://dell.com/regulatory_compliance).

## Prerequisites

Remove the battery. See "Removing the Battery" on page 12.

## Procedure

- 1 Remove the screws that secure the keyboard to the computer base



---

1 screws (2)

---

- 2 Turn the computer over and open the display as far as possible.
- 3 Using a plastic scribe, pry the keyboard from the tabs on the palm-rest.



---

1	tabs (5)	2	plastic scribe
3	keyboard		

---

- 4 Lift and slide the keyboard towards the display to release the keyboard from the palm-rest and place the keyboard on the palm-rest.
- 5 Lift the connector latch and disconnect the keyboard cable from the keyboard-cable connector.
- 6 Lift the keyboard off the palm-rest.



1	keyboard	2	palm-rest
3	keyboard cable	4	connector latch

# Replacing the Keyboard

---



**WARNING:** Before working inside your computer, read the safety information that shipped with your computer and follow the steps in "Before You Begin" on page 9. After working inside your computer, follow the instructions in "After Working Inside Your Computer" on page 11. For additional safety best practices information, see the Regulatory Compliance Homepage at [dell.com/regulatory\\_compliance](http://dell.com/regulatory_compliance).

## Procedure

- 1 Slide the keyboard cable into the keyboard-cable connector and press down on the connector latch to secure the cable.
- 2 Slide the tabs at the bottom of the keyboard into the slots on the palm-rest and place the keyboard on the palm-rest.
- 3 Gently press around the edges of the keyboard to secure the keyboard under the tabs on the palm-rest.
- 4 Replace the screws that secure the keyboard to the computer base.

## Postrequisites

Replace the battery. See "Replacing the Battery" on page 13.

# Removing the Base Cover

---

**⚠ WARNING:** Before working inside your computer, read the safety information that shipped with your computer and follow the steps in "Before You Begin" on page 9. After working inside your computer, follow the instructions in "After Working Inside Your Computer" on page 11. For additional safety best practices information, see the Regulatory Compliance Homepage at [dell.com/regulatory\\_compliance](http://dell.com/regulatory_compliance).

## Prerequisites

Remove the battery. See "Removing the Battery" on page 12.

## Procedure

- 1 Remove the screw that secures the base cover to the computer base.
- 2 Using your fingertips, lift the base cover out of the slots on the computer base.



---

1 screw

2 base cover

---

# Replacing the Base Cover

---



**WARNING:** Before working inside your computer, read the safety information that shipped with your computer and follow the steps in "Before You Begin" on page 9. After working inside your computer, follow the instructions in "After Working Inside Your Computer" on page 11. For additional safety best practices information, see the Regulatory Compliance Homepage at [dell.com/regulatory\\_compliance](http://dell.com/regulatory_compliance).

## Procedure

- 1 Slide the tabs on the base cover into the slots on the computer base and snap the base cover into place.
- 2 Replace the screw that secures the base cover to the computer base.

## Postrequisites

Replace the battery. See "Replacing the Battery" on page 13.

# Removing the Memory Module(s)

---

**⚠ WARNING:** Before working inside your computer, read the safety information that shipped with your computer and follow the steps in "Before You Begin" on page 9. After working inside your computer, follow the instructions in "After Working Inside Your Computer" on page 11. For additional safety best practices information, see the Regulatory Compliance Homepage at [dell.com/regulatory\\_compliance](http://dell.com/regulatory_compliance).

## Prerequisites

- 1 Remove the battery. See "Removing the Battery" on page 12.
- 2 Remove the base cover. See "Removing the Base Cover" on page 21.

## Procedure

- 1 Use your fingertips to carefully spread apart the securing-clips on each end of the memory-module connector until the memory module pops up.
- 2 Remove the memory module from the memory-module connector.

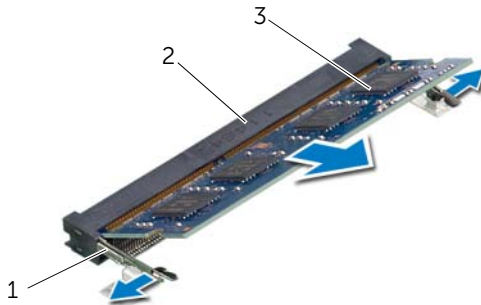

---

1	securing-clips (2)	2	memory-module connector
3	memory module		

---

# Replacing the Memory Module(s)

---



**WARNING:** Before working inside your computer, read the safety information that shipped with your computer and follow the steps in "Before You Begin" on page 9. After working inside your computer, follow the instructions in "After Working Inside Your Computer" on page 11. For additional safety best practices information, see the Regulatory Compliance Homepage at [dell.com/regulatory\\_compliance](http://dell.com/regulatory_compliance).

## Procedure

- 1 Align the notch on the memory module with the tab on the memory-module connector.
- 2 Slide the memory module firmly into the connector at a 45-degree angle and press the memory module down until it clicks into place.



**NOTE:** If you do not hear the click, remove the memory module and reinstall it.

## Postrequisites

- 1 Replace the base cover. See "Replacing the Base Cover" on page 22.
- 2 Replace the battery. See "Replacing the Battery" on page 13.



# Removing the Hard Drive

---

 **WARNING:** Before working inside your computer, read the safety information that shipped with your computer and follow the steps in "Before You Begin" on page 9. After working inside your computer, follow the instructions in "After Working Inside Your Computer" on page 11. For additional safety best practices information, see the Regulatory Compliance Homepage at [dell.com/regulatory\\_compliance](http://dell.com/regulatory_compliance).

 **CAUTION:** To avoid data loss, do not remove the hard drive while the computer is in Sleep or On state.

 **CAUTION:** Hard drives are extremely fragile. Exercise care when handling the hard drive.

## Prerequisites

- 1 Remove the battery. See "Removing the Battery" on page 12.
- 2 Remove the base cover. See "Removing the Base Cover" on page 21.

## Procedure

- 1 Remove the screw that secures the hard-drive assembly to the computer base.
- 2 Slide the hard-drive assembly towards the side of the computer to disconnect the hard-drive assembly from the system board.
- 3 Lift and slide the hard-drive assembly out of tabs on the computer base.

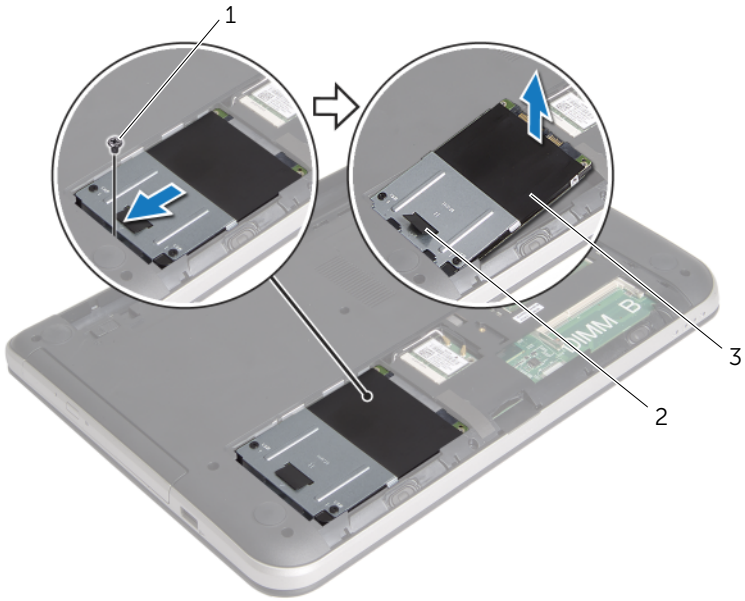

1	screw	2	pull-tab
3	hard-drive assembly		

- 4 Remove the screws that secure the hard-drive bracket to the hard drive.
- 5 Using the pull-tab, lift the hard-drive bracket off the hard drive.

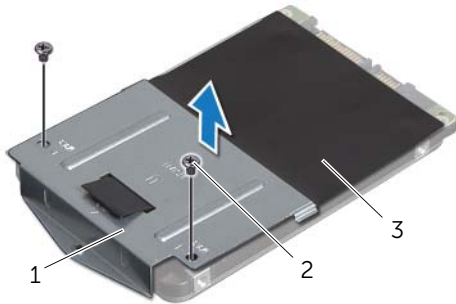

1	hard-drive bracket	2	screws (2)
3	hard drive		

# Replacing the Hard Drive

---

 **WARNING:** Before working inside your computer, read the safety information that shipped with your computer and follow the steps in "Before You Begin" on page 9. After working inside your computer, follow the instructions in "After Working Inside Your Computer" on page 11. For additional safety best practices information, see the Regulatory Compliance Homepage at [dell.com/regulatory\\_compliance](http://dell.com/regulatory_compliance).

 **CAUTION:** Hard drives are extremely fragile. Exercise care when handling the hard drive.

## Procedure

- 1 Align the screw holes on the hard-drive bracket with the screw holes on the hard drive.
- 2 Replace the screws that secure the hard-drive bracket to the hard drive.
- 3 Slide the hard-drive assembly under the tabs on the computer base and place the hard-drive assembly in the hard-drive bay.
- 4 Slide the hard-drive assembly towards the side of the computer to connect the hard-drive assembly to the system board.
- 5 Replace the screw that secures the hard-drive assembly to the computer base.

## Postrequisites

- 1 Replace the base cover. See "Replacing the Base Cover" on page 22.
- 2 Replace the battery. See "Replacing the Battery" on page 13.

# Removing the Wireless Mini-Card

**⚠ WARNING:** Before working inside your computer, read the safety information that shipped with your computer and follow the steps in "Before You Begin" on page 9. After working inside your computer, follow the instructions in "After Working Inside Your Computer" on page 11. For additional safety best practices information, see the Regulatory Compliance Homepage at [dell.com/regulatory\\_compliance](http://dell.com/regulatory_compliance).

## Prerequisites

- 1 Remove the battery. See "Removing the Battery" on page 12.
- 2 Remove the base cover. See "Removing the Base Cover" on page 21.

## Procedure

- 1 Disconnect the antenna cables from the wireless mini-card.
- 2 Remove the screw that secures the wireless mini-card to the system board.

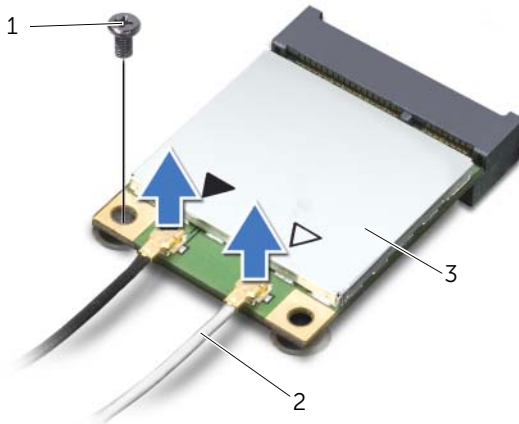

1 screw

2 antenna cables (2)

3 wireless mini-card

3 Slide and remove the wireless mini-card out of the mini-card connector.

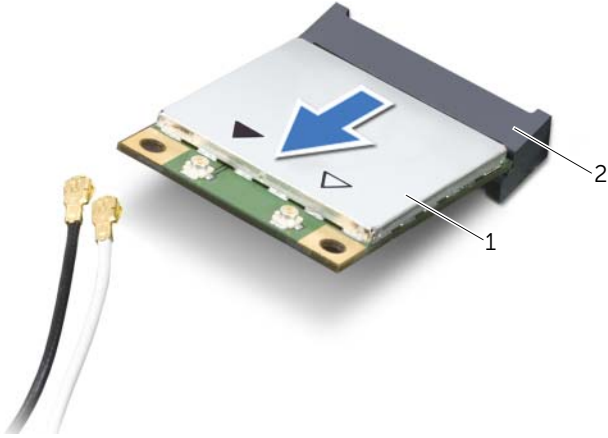

---

1 wireless mini-card

2 mini-card connector

---

# Replacing the Wireless Mini-Card

---

 **WARNING:** Before working inside your computer, read the safety information that shipped with your computer and follow the steps in "Before You Begin" on page 9. After working inside your computer, follow the instructions in "After Working Inside Your Computer" on page 11. For additional safety best practices information, see the Regulatory Compliance Homepage at [dell.com/regulatory\\_compliance](http://dell.com/regulatory_compliance).

## Procedure

 **CAUTION:** To avoid damage to the wireless mini-card, ensure that no cables are placed under the wireless mini-card.

- 1 Align the notch on the wireless mini-card with the tab on the mini-card connector.
- 2 Insert the wireless mini-card at a 45-degree angle into the mini-card connector.
- 3 Press the other end of the wireless mini-card down and replace the screw that secures the wireless mini-card to the system board.
- 4 Connect the antenna cables to the wireless mini-card.

The following table provides the antenna cable color schemes for the wireless mini-card supported by your computer.

Connectors on the wireless mini-card	Antenna cable color schemes
<b>WLAN + Bluetooth (2 cables)</b>	
Main WLAN + Bluetooth (white triangle)	white
Auxiliary WLAN + Bluetooth (black triangle)	black

## Postrequisites

- 1 Replace the base cover. See "Replacing the Base Cover" on page 22.
- 2 Replace the battery. See "Replacing the Battery" on page 13.

# Removing the Palm-Rest

---

**⚠ WARNING:** Before working inside your computer, read the safety information that shipped with your computer and follow the steps in "Before You Begin" on page 9. After working inside your computer, follow the instructions in "After Working Inside Your Computer" on page 11. For additional safety best practices information, see the Regulatory Compliance Homepage at [dell.com/regulatory\\_compliance](http://dell.com/regulatory_compliance).

## Prerequisites

- 1 Remove the battery. See "Removing the Battery" on page 12.
- 2 Remove the base cover. See "Removing the Base Cover" on page 21.
- 3 Follow the instructions from step 1 to step 3 in "Removing the Hard Drive" on page 25.
- 4 Remove the keyboard. See "Removing the Keyboard" on page 17.

## Procedure

- 1 Remove the screws that secure the palm-rest to the computer base.

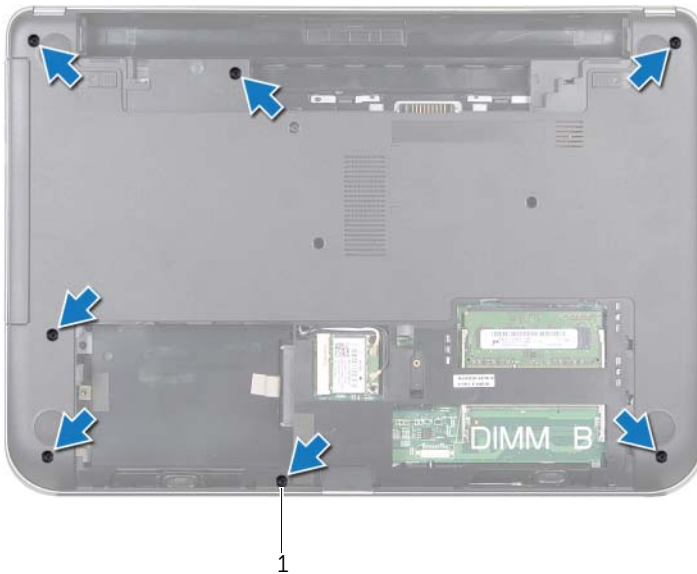

---

1 screws (7)

---

2 Press the latches to release the palm-rest from the computer base.



---

1 latches (4)

---



- 3 Turn the computer over and open the display as far as possible.
- 4 Remove the screws that secure the palm-rest to the computer base.
- 5 Lift the connector latches and, using the pull-tabs, disconnect the touchpad cable and the power-button cable from the system board.

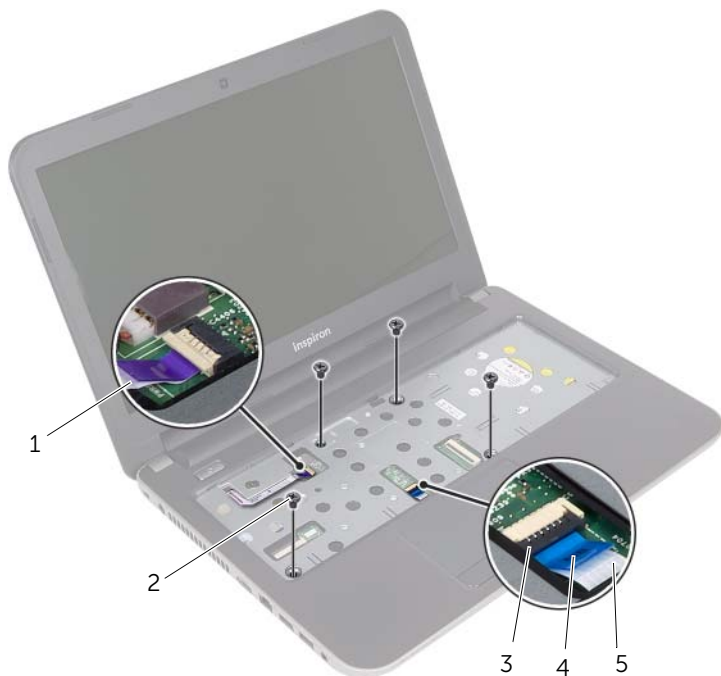

1	power-button cable	2	screws (4)
3	connector latches (2)	4	pull-tab
5	touchpad cable		

6 Using a plastic scribe, gently lift and release the tabs on the palm-rest from the slots on the computer base.

**CAUTION:** Separate the palm-rest from the display assembly carefully to avoid damage to the display assembly.

7 Lift the palm-rest off the computer base.



---

1 palm-rest

2 plastic scribe

---

# Replacing the Palm-Rest

---



**WARNING:** Before working inside your computer, read the safety information that shipped with your computer and follow the steps in "Before You Begin" on page 9. After working inside your computer, follow the instructions in "After Working Inside Your Computer" on page 11. For additional safety best practices information, see the Regulatory Compliance Homepage at [dell.com/regulatory\\_compliance](http://dell.com/regulatory_compliance).

## Procedure

- 1 Align the palm-rest over the computer base.
- 2 Press down on the edges of the palm-rest to snap it into place.
- 3 Replace the screws that secure the palm-rest to the computer base.
- 4 Slide the touchpad cable and the power-button cable into the system-board connectors and press down on the connector latches to secure the cables.
- 5 Close the display and turn the computer over.
- 6 Replace the screws that secure the palm-rest to the computer base.

## Postrequisites

- 1 Replace the keyboard. See "Replacing the Keyboard" on page 20.
- 2 Follow the instructions from step 3 to step 5 in "Replacing the Hard Drive" on page 27.
- 3 Replace the base cover. See "Replacing the Base Cover" on page 22.
- 4 Replace the battery. See "Replacing the Battery" on page 13.

# Removing the Coin-Cell Battery

---

 **WARNING:** Before working inside your computer, read the safety information that shipped with your computer and follow the steps in "Before You Begin" on page 9. After working inside your computer, follow the instructions in "After Working Inside Your Computer" on page 11. For additional safety best practices information, see the Regulatory Compliance Homepage at [dell.com/regulatory\\_compliance](http://dell.com/regulatory_compliance).

 **CAUTION:** Removing the coin-cell battery resets the BIOS settings to default. It is recommended that you note the BIOS settings before removing the coin-cell battery.

## Prerequisites

- 1 Remove the battery. See "Removing the Battery" on page 12.
- 2 Remove the base cover. See "Removing the Base Cover" on page 21.
- 3 Follow the instructions from step 1 to step 3 in "Removing the Hard Drive" on page 25.
- 4 Remove the keyboard. See "Removing the Keyboard" on page 17.
- 5 Remove the palm-rest. See "Removing the Palm-Rest" on page 31.

# Procedure

Using a plastic scribe, gently pry out the coin-cell battery out of the battery socket on the system board.



---

1	plastic scribe	2	coin-cell battery
3	battery socket		

---

# Replacing the Coin-Cell Battery

---

 **WARNING:** Before working inside your computer, read the safety information that shipped with your computer and follow the steps in "Before You Begin" on page 9. After working inside your computer, follow the instructions in "After Working Inside Your Computer" on page 11. For additional safety best practices information, see the Regulatory Compliance Homepage at [dell.com/regulatory\\_compliance](http://dell.com/regulatory_compliance).

 **WARNING:** The battery may explode if installed incorrectly. Replace the battery only with the same or equivalent type. Discard used batteries according to the manufacturer's instructions.

## Procedure

With the positive-side facing up, snap the coin-cell battery into the battery socket on the system board.

## Postrequisites

- 1 Replace the palm-rest. See "Replacing the Palm-Rest" on page 35.
- 2 Replace the keyboard. See "Replacing the Keyboard" on page 20.
- 3 Follow the instructions from step 3 to step 5 in "Replacing the Hard Drive" on page 27.
- 4 Replace the base cover. See "Replacing the Base Cover" on page 22.
- 5 Replace the battery. See "Replacing the Battery" on page 13.

# Removing the I/O Board

---



**WARNING:** Before working inside your computer, read the safety information that shipped with your computer and follow the steps in "Before You Begin" on page 9. After working inside your computer, follow the instructions in "After Working Inside Your Computer" on page 11. For additional safety best practices information, see the Regulatory Compliance Homepage at [dell.com/regulatory\\_compliance](http://dell.com/regulatory_compliance).

## Prerequisites

- 1 Remove the battery. See "Removing the Battery" on page 12.
- 2 Remove the base cover. See "Removing the Base Cover" on page 21.
- 3 Follow the instructions from step 1 to step 3 in "Removing the Hard Drive" on page 25.
- 4 Remove the keyboard. See "Removing the Keyboard" on page 17.
- 5 Remove the palm-rest. See "Removing the Palm-Rest" on page 31.

# Procedure

- 1 Lift the connector latch and, using the pull-tab, disconnect the I/O-board cable from the I/O-board.
- 2 Remove the screw that secures the I/O board to the computer base.
- 3 Lift the I/O board off the computer base.



1	I/O board	2	connector latch
3	pull-tab	4	I/O board cable
5	screw		



# Replacing the I/O Board

---



**WARNING:** Before working inside your computer, read the safety information that shipped with your computer and follow the steps in "Before You Begin" on page 9. After working inside your computer, follow the instructions in "After Working Inside Your Computer" on page 11. For additional safety best practices information, see the Regulatory Compliance Homepage at [dell.com/regulatory\\_compliance](http://dell.com/regulatory_compliance).

## Procedure

- 1 Use the alignment posts on the computer base to place the I/O board in position.
- 2 Replace the screw that secures the I/O board to the computer base.
- 3 Slide the I/O-board cable into the I/O-board-cable connector and press down on the connector latch to secure the cable.

## Postrequisites

- 1 Replace the palm-rest. See "Replacing the Palm-Rest" on page 35.
- 2 Replace the keyboard. See "Replacing the Keyboard" on page 20.
- 3 Follow the instructions from step 3 to step 5 in "Replacing the Hard Drive" on page 27.
- 4 Replace the base cover. See "Replacing the Base Cover" on page 22.
- 5 Replace the battery. See "Replacing the Battery" on page 13.

# Removing the Power-Adapter Port

---



**WARNING:** Before working inside your computer, read the safety information that shipped with your computer and follow the steps in "Before You Begin" on page 9. After working inside your computer, follow the instructions in "After Working Inside Your Computer" on page 11. For additional safety best practices information, see the Regulatory Compliance Homepage at [dell.com/regulatory\\_compliance](http://dell.com/regulatory_compliance).

## Prerequisites

- 1 Remove the battery. See "Removing the Battery" on page 12.
- 2 Remove the base cover. See "Removing the Base Cover" on page 21.
- 3 Follow the instructions from step 1 to step 3 in "Removing the Hard Drive" on page 25.
- 4 Remove the keyboard. See "Removing the Keyboard" on page 17.
- 5 Remove the palm-rest. See "Removing the Palm-Rest" on page 31.

# Procedure

- 1 Peel the tape that secures the display cable to the display-cable connector.
- 2 Lift the connector latch and pull the tape to disconnect the display cable from the display-cable connector.



---

1	display cable	2	tape
3	connector latch		

---

- 3 Peel the display cable from the fan.
- 4 Move the display cable away from the power-adapter-port cable.

- 5 Disconnect the power-adaptor-port cable from the system board.
- 6 Note the power-adaptor-port cable routing and remove it from the routing guides on the computer base.
- 7 Lift the power-adaptor port, along with its cable, off the computer base.



---

1	power-adaptor port	2	routing guides
3	power-adaptor-port cable		

---

# Replacing the Power-Adapter Port

---



**WARNING:** Before working inside your computer, read the safety information that shipped with your computer and follow the steps in "Before You Begin" on page 9. After working inside your computer, follow the instructions in "After Working Inside Your Computer" on page 11. For additional safety best practices information, see the Regulatory Compliance Homepage at [dell.com/regulatory\\_compliance](http://dell.com/regulatory_compliance).

## Procedure

- 1 Slide the power-adapter port into position.
- 2 Route the power-adapter-port cable through the routing guides on the computer base.
- 3 Connect the power-adapter-port cable to the system board.
- 4 Adhere the display cable to the fan.
- 5 Slide the display cable into the system-board connector and press down on the connector latch to secure the cable.
- 6 Adhere the tape to the system board.

## Postrequisites

- 1 Replace the palm-rest. See "Replacing the Palm-Rest" on page 35.
- 2 Replace the keyboard. See "Replacing the Keyboard" on page 20.
- 3 Follow the instructions from step 3 to step 5 in "Replacing the Hard Drive" on page 27.
- 4 Replace the base cover. See "Replacing the Base Cover" on page 22.
- 5 Replace the battery. See "Replacing the Battery" on page 13.

# Removing the System Board

---



**WARNING:** Before working inside your computer, read the safety information that shipped with your computer and follow the steps in "Before You Begin" on page 9. After working inside your computer, follow the instructions in "After Working Inside Your Computer" on page 11. For additional safety best practices information, see the Regulatory Compliance Homepage at [dell.com/regulatory\\_compliance](http://dell.com/regulatory_compliance).



**NOTE:** Your computer's Service Tag is stored in the system board. You must enter the Service Tag in system setup after you replace the system board.



**NOTE:** Before disconnecting the cables from the system board, note the location of the connectors so that you can reconnect them correctly after you replace the system board.

## Prerequisites

- 1 Remove the battery. See "Removing the Battery" on page 12.
- 2 Follow the instructions from step 1 to step 2 in "Removing the Optical Drive" on page 14.
- 3 Remove the base cover. See "Removing the Base Cover" on page 21.
- 4 Remove the memory module(s). See "Removing the Memory Module(s)" on page 23.
- 5 Follow the instructions from step 1 to step 3 in "Removing the Hard Drive" on page 25.
- 6 Remove the wireless Mini-Card. See "Removing the Wireless Mini-Card" on page 28.
- 7 Remove the keyboard. See "Removing the Keyboard" on page 17.
- 8 Remove the palm-rest. See "Removing the Palm-Rest" on page 31.
- 9 Remove the coin-cell battery. See "Removing the Coin-Cell Battery" on page 36.

# Procedure

- 1 Peel the tape that secures the display cable to the system-board connector.
- 2 Lift the connector latch and, using the pull-tab, disconnect the display cable from the system-board connector.
- 3 Peel the display cable from the fan.
- 4 Lift the connector latch and, using the pull-tab, disconnect the I/O-board cable from the system-board connector.
- 5 Disconnect the power-adaptor-port cable and speaker cable from the system-board connectors.



1	power-adaptor-port cable	2	connector latches (2)
3	pull-tab	4	I/O-board cable
5	speaker cable	6	tape
7	display cable		

- 6 Remove the screw that secures the system board to the computer base.
- 7 Lift the system board at an angle and release the system-board ports from the slots on the computer base.
- 8 Lift the system-board assembly off the computer base.



---

1 system board

2 screw

---

- 9 Turn the system board over.
- 10 Remove the thermal-cooling assembly. See "Removing the Thermal-Cooling Assembly" on page 51.



# Replacing the System Board

---



**WARNING:** Before working inside your computer, read the safety information that shipped with your computer and follow the steps in "Before You Begin" on page 9. After working inside your computer, follow the instructions in "After Working Inside Your Computer" on page 11. For additional safety best practices information, see the Regulatory Compliance Homepage at [dell.com/regulatory\\_compliance](http://dell.com/regulatory_compliance).



**NOTE:** Your computer's Service Tag is stored in the system board. You must enter the Service Tag in the system setup after you replace the system board.

## Procedure

- 1 Replace the thermal-cooling assembly. See "Replacing the Thermal-Cooling Assembly" on page 52.
- 2 Turn the system board over.
- 3 Ease the system-board ports into the slots on the computer base and align the screw hole on the system board with the screw hole on the computer base.
- 4 Replace the screw that secures the system board to the computer base.
- 5 Connect the power-adapter-port cable and speaker cable to the system-board connectors.
- 6 Slide the I/O-board cable into the system-board connector and press down on the connector latch to secure the cable.
- 7 Adhere the display cable to the fan.
- 8 Slide the display cable into the system-board connector and press down on the connector latch to secure the cable.
- 9 Adhere the tape to the system-board connector.

## Postrequisites

- 1 Replace the coin-cell battery. See "Replacing the Coin-Cell Battery" on page 38
- 2 Replace the palm-rest. See "Replacing the Palm-Rest" on page 35.
- 3 Replace the keyboard. See "Replacing the Keyboard" on page 20.
- 4 Replace the wireless Mini-Card. See "Replacing the Wireless Mini-Card" on page 30.
- 5 Follow the instructions from step 3 to step 5 in "Replacing the Hard Drive" on page 27.
- 6 Replace the memory module(s). See "Replacing the Memory Module(s)" on page 24.
- 7 Replace the base cover. See "Replacing the Base Cover" on page 22.
- 8 Follow the instructions from step 3 to step 4 in "Replacing the Optical Drive" on page 16.
- 9 Replace the battery. See "Replacing the Battery" on page 13.

## Entering the Service Tag in system setup

- 1 Turn on the computer.
- 2 Press <F2> during POST to enter the system setup program.
- 3 Using the arrow keys, select **Enter Setup** and press <Enter>.
- 4 Navigate to the **Main** tab and enter your computer's Service Tag in the **Service Tag** field.

# Removing the Thermal-Cooling Assembly

**⚠ WARNING:** Before working inside your computer, read the safety information that shipped with your computer and follow the steps in "Before You Begin" on page 9. After working inside your computer, follow the instructions in "After Working Inside Your Computer" on page 11. For additional safety best practices information, see the Regulatory Compliance Homepage at [dell.com/regulatory\\_compliance](http://dell.com/regulatory_compliance).

## Prerequisites

- 1 Remove the battery. See "Removing the Battery" on page 12.
- 2 Follow the instructions from step 1 to step 2 in "Removing the Optical Drive" on page 14.
- 3 Remove the base cover. See "Removing the Base Cover" on page 21.
- 4 Remove the keyboard. See "Removing the Keyboard" on page 17.
- 5 Remove the palm-rest. See "Removing the Palm-Rest" on page 31.
- 6 Follow the instructions from step 1 to step 9 in "Removing the System Board" on page 46.

## Procedure

- 1 In sequential order (indicated on the heat-sink), loosen the captive screws that secure the thermal-cooling assembly to the system board.
- 2 Lift the thermal-cooling assembly off the system board.

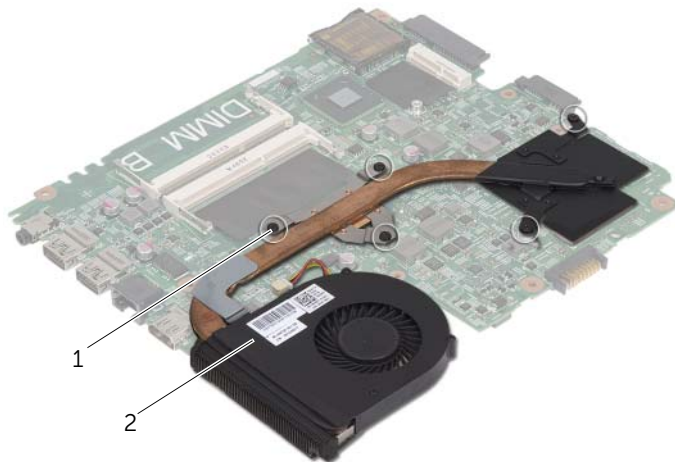

1 captive screws (5)

2 thermal-cooling assembly

# Replacing the Thermal-Cooling Assembly

---



**WARNING:** Before working inside your computer, read the safety information that shipped with your computer and follow the steps in "Before You Begin" on page 9. After working inside your computer, follow the instructions in "After Working Inside Your Computer" on page 11. For additional safety best practices information, see the Regulatory Compliance Homepage at [dell.com/regulatory\\_compliance](http://dell.com/regulatory_compliance).

## Procedure

- 1 Clean the thermal grease from the bottom of the thermal-cooling assembly and reapply it.
- 2 Align the screw holes on the thermal-cooling assembly with the screw holes on the system board.
- 3 In sequential order (indicated on the heat-sink), tighten the captive screws that secure the thermal-cooling assembly to the system board

## Postrequisites

- 1 Follow the instructions from step 2 to step 9 in "Replacing the System Board" on page 49.
- 2 Replace the palm-rest. See "Replacing the Palm-Rest" on page 35.
- 3 Replace the keyboard. See "Replacing the Keyboard" on page 20.
- 4 Replace the base cover. See "Replacing the Base Cover" on page 22.
- 5 Follow the instructions from step 3 to step 4 in "Replacing the Optical Drive" on page 16.
- 6 Replace the battery. See "Replacing the Battery" on page 13.

# Removing the Speakers

---



**WARNING:** Before working inside your computer, read the safety information that shipped with your computer and follow the steps in "Before You Begin" on page 9. After working inside your computer, follow the instructions in "After Working Inside Your Computer" on page 11. For additional safety best practices information, see the Regulatory Compliance Homepage at [dell.com/regulatory\\_compliance](http://dell.com/regulatory_compliance).

## Prerequisites

- 1 Remove the battery. See "Removing the Battery" on page 12.
- 2 Follow the instructions from step 1 to step 2 in "Removing the Optical Drive" on page 14.
- 3 Remove the base cover. See "Removing the Base Cover" on page 21.
- 4 Remove the keyboard. See "Removing the Keyboard" on page 17.
- 5 Remove the palm-rest. See "Removing the Palm-Rest" on page 31.
- 6 Follow the instructions from step 1 to step 8 in "Removing the System Board" on page 46.

# Procedure

- 1 Note the speaker-cable routing and remove the cable from its routing guides.
- 2 Lift the speakers, along with the speaker cable, off the computer base.



---

1	speaker cable	2	speakers (2)
---	---------------	---	--------------

---

# Replacing the Speakers

---



**WARNING:** Before working inside your computer, read the safety information that shipped with your computer and follow the steps in "Before You Begin" on page 9. After working inside your computer, follow the instructions in "After Working Inside Your Computer" on page 11. For additional safety best practices information, see the Regulatory Compliance Homepage at [dell.com/regulatory\\_compliance](http://dell.com/regulatory_compliance).

## Procedure

- 1 Using the alignment posts on the computer base, place the speakers in position.
- 2 Route the speakers cable through the routing guides on the computer base.

## Postrequisites

- 1 Follow the instructions from step 3 to step 9 in "Replacing the System Board" on page 49.
- 2 Replace the palm-rest. See "Replacing the Palm-Rest" on page 35.
- 3 Replace the keyboard. See "Replacing the Keyboard" on page 20.
- 4 Replace the base cover. See "Replacing the Base Cover" on page 22.
- 5 Follow the instructions from step 3 to step 4 in "Replacing the Optical Drive" on page 16.
- 6 Replace the battery. See "Replacing the Battery" on page 13.

# Removing the Display Assembly

---



**WARNING:** Before working inside your computer, read the safety information that shipped with your computer and follow the steps in "Before You Begin" on page 9. After working inside your computer, follow the instructions in "After Working Inside Your Computer" on page 11. For additional safety best practices information, see the Regulatory Compliance Homepage at [dell.com/regulatory\\_compliance](http://dell.com/regulatory_compliance).

## Prerequisites

- 1 Remove the battery. See "Removing the Battery" on page 12.
- 2 Follow the instructions from step 1 to step 2 in "Removing the Optical Drive" on page 14.
- 3 Remove the base cover. See "Removing the Base Cover" on page 21.
- 4 Remove the keyboard. See "Removing the Keyboard" on page 17.
- 5 Remove the palm-rest. See "Removing the Palm-Rest" on page 31.
- 6 Follow the instructions from step 1 to step 8 in "Removing the System Board" on page 46.



# Procedure

- 1 Note the antenna cable routing and remove the cable from its routing guides.
- 2 Remove the screws that secure the display assembly to the computer base.
- 3 Lift the display assembly off the computer base.



---

1	display assembly	2	screws (4)
3	routing guides		

---

# Replacing the Display Assembly

---



**WARNING:** Before working inside your computer, read the safety information that shipped with your computer and follow the steps in "Before You Begin" on page 9. After working inside your computer, follow the instructions in "After Working Inside Your Computer" on page 11. For additional safety best practices information, see the Regulatory Compliance Homepage at [dell.com/regulatory\\_compliance](http://dell.com/regulatory_compliance).

## Procedure

- 1 Place the display assembly on the computer base and align the screw holes on the display assembly with the screw holes on the computer base.
- 2 Replace the screws that secure the display assembly to the computer base.
- 3 Route the antenna cable through the routing guides on the computer base.

## Postrequisites

- 1 Follow the instructions from step 3 to step 9 in "Replacing the System Board" on page 49.
- 2 Replace the palm-rest. See "Replacing the Palm-Rest" on page 35.
- 3 Replace the keyboard. See "Replacing the Keyboard" on page 20.
- 4 Replace the base cover. See "Replacing the Base Cover" on page 22.
- 5 Follow the instructions from step 3 to step 4 in "Replacing the Optical Drive" on page 16.
- 6 Replace the battery. See "Replacing the Battery" on page 13.

# Removing the Display Bezel

---



**WARNING:** Before working inside your computer, read the safety information that shipped with your computer and follow the steps in "Before You Begin" on page 9. After working inside your computer, follow the instructions in "After Working Inside Your Computer" on page 11. For additional safety best practices information, see the Regulatory Compliance Homepage at [dell.com/regulatory\\_compliance](http://dell.com/regulatory_compliance).

## Prerequisites

- 1 Remove the battery. See "Removing the Battery" on page 12.
- 2 Follow the instructions from step 1 to step 2 in "Removing the Optical Drive" on page 14.
- 3 Remove the base cover. See "Removing the Base Cover" on page 21.
- 4 Remove the keyboard. See "Removing the Keyboard" on page 17.
- 5 Remove the palm-rest. See "Removing the Palm-Rest" on page 31.
- 6 Follow the instructions from step 1 to step 8 in "Removing the System Board" on page 46.
- 7 Remove the display assembly. See "Removing the Display Assembly" on page 56.

# Procedure

- 1 Press the hinge covers on the sides and lift the hinge covers to remove them from the display assembly.



---

1 hinge covers (2)

---

- 2 Using your fingertips, carefully pry up the inside edge of the display bezel.
- 3 Remove the display bezel off the display back-cover.



---

1 display bezel

---

# Replacing the Display Bezel

---



**WARNING:** Before working inside your computer, read the safety information that shipped with your computer and follow the steps in "Before You Begin" on page 9. After working inside your computer, follow the instructions in "After Working Inside Your Computer" on page 11. For additional safety best practices information, see the Regulatory Compliance Homepage at [dell.com/regulatory\\_compliance](http://dell.com/regulatory_compliance).

## Procedure

- 1 Align the display bezel with the display back-cover, and gently snap the display bezel into place.
- 2 Align the hinge covers with the hinges on the display assembly and snap the hinge covers into place.

## Postrequisites

- 1 Replace the display assembly. See "Replacing the Display Assembly" on page 58.
- 2 Follow the instructions from step 3 to step 9 in "Replacing the System Board" on page 49.
- 3 Replace the palm-rest. See "Replacing the Palm-Rest" on page 35.
- 4 Replace the keyboard. See "Replacing the Keyboard" on page 20.
- 5 Replace the base cover. See "Replacing the Base Cover" on page 22.
- 6 Follow the instructions from step 3 to step 4 in "Replacing the Optical Drive" on page 16.
- 7 Replace the battery. See "Replacing the Battery" on page 13.

# Removing the Display Hinges

---



**WARNING:** Before working inside your computer, read the safety information that shipped with your computer and follow the steps in "Before You Begin" on page 9. After working inside your computer, follow the instructions in "After Working Inside Your Computer" on page 11. For additional safety best practices information, see the Regulatory Compliance Homepage at [dell.com/regulatory\\_compliance](http://dell.com/regulatory_compliance).

## Prerequisites

- 1 Remove the battery. See "Removing the Battery" on page 12.
- 2 Follow the instructions from step 1 to step 2 in "Removing the Optical Drive" on page 14.
- 3 Remove the base cover. See "Removing the Base Cover" on page 21.
- 4 Remove the keyboard. See "Removing the Keyboard" on page 17.
- 5 Remove the palm-rest. See "Removing the Palm-Rest" on page 31.
- 6 Follow the instructions from step 1 to step 8 in "Removing the System Board" on page 46.
- 7 Remove the display assembly. See "Removing the Display Assembly" on page 56.
- 8 Remove the display bezel. See "Removing the Display Bezel" on page 59.

# Procedure

- 1 Remove the screws that secure the display hinges to the display back-cover.
- 2 Lift the display hinges off the display back-cover.

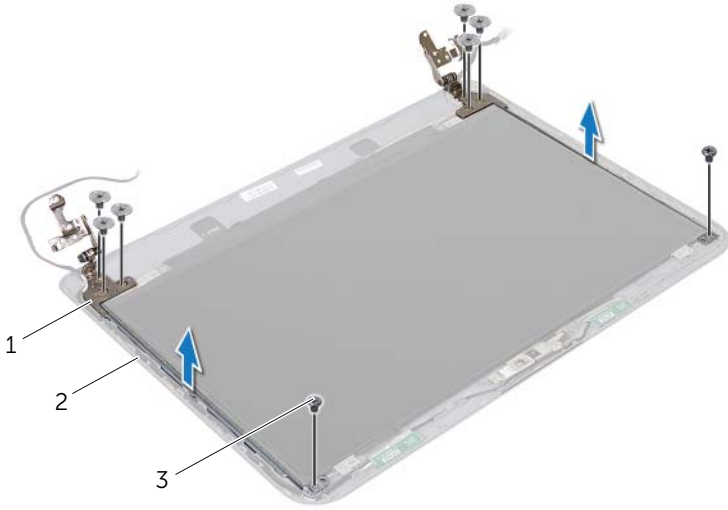

---

1	display hinges (2)	2	display back-cover
3	screws (8)		

---

# Replacing the Display Hinges

---



**WARNING:** Before working inside your computer, read the safety information that shipped with your computer and follow the steps in "Before You Begin" on page 9. After working inside your computer, follow the instructions in "After Working Inside Your Computer" on page 11. For additional safety best practices information, see the Regulatory Compliance Homepage at [dell.com/regulatory\\_compliance](http://dell.com/regulatory_compliance).

## Procedure

- 1 Align the screw holes on the display hinges with the screw holes on the display back-cover.
- 2 Replace the screws that secure the display hinges to the display back-cover.

## Postrequisites

- 1 Replace the display bezel. See "Replacing the Display Bezel" on page 61.
- 2 Replace the display assembly. See "Replacing the Display Assembly" on page 58.
- 3 Follow the instructions from step 3 to step 9 in "Replacing the System Board" on page 49.
- 4 Replace the palm-rest. See "Replacing the Palm-Rest" on page 35.
- 5 Replace the keyboard. See "Replacing the Keyboard" on page 20.
- 6 Replace the base cover. See "Replacing the Base Cover" on page 22.
- 7 Follow the instructions from step 3 to step 4 in "Replacing the Optical Drive" on page 16.
- 8 Replace the battery. See "Replacing the Battery" on page 13.



# Removing the Display Panel

---



**WARNING:** Before working inside your computer, read the safety information that shipped with your computer and follow the steps in "Before You Begin" on page 9. After working inside your computer, follow the instructions in "After Working Inside Your Computer" on page 11. For additional safety best practices information, see the Regulatory Compliance Homepage at [dell.com/regulatory\\_compliance](http://dell.com/regulatory_compliance).

## Prerequisites

- 1 Remove the battery. See "Removing the Battery" on page 12.
- 2 Follow the instructions from step 1 to step 2 in "Removing the Optical Drive" on page 14.
- 3 Remove the base cover. See "Removing the Base Cover" on page 21.
- 4 Remove the memory module(s). See "Removing the Memory Module(s)" on page 23.
- 5 Follow the instructions from step 1 to step 3 in "Removing the Hard Drive" on page 25.
- 6 Remove the wireless Mini-Card. See "Removing the Wireless Mini-Card" on page 28.
- 7 Remove the keyboard. See "Removing the Keyboard" on page 17.
- 8 Remove the palm-rest. See "Removing the Palm-Rest" on page 31.
- 9 Follow the instructions from step 1 to step 8 in "Removing the System Board" on page 46.
- 10 Remove the display assembly. See "Removing the Display Assembly" on page 56.
- 11 Remove the display bezel. See "Removing the Display Bezel" on page 59.
- 12 Remove the display hinges. See "Removing the Display Hinges" on page 62.

# Procedure

- 1 Remove the screws that secure the display panel to the display back-cover.
- 2 Gently lift the display panel and turn it over.

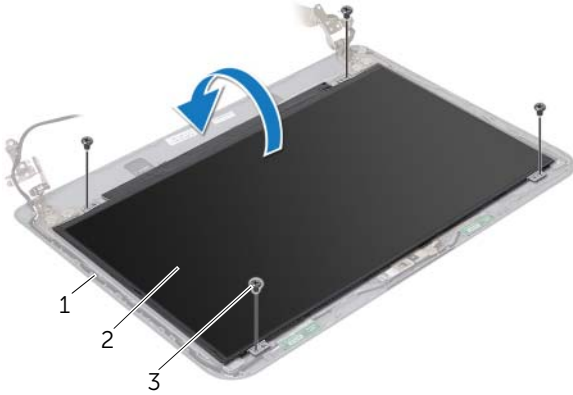

---

1	display back-cover	2	display panel
3	screw (4)		

---

- 3 Peel the tape adhered over the display cable.
- 4 Disconnect the display cable from the display-panel cable connector.



---

1	tape	2	display cable
---	------	---	---------------

---

# Replacing the Display Panel

---



**WARNING:** Before working inside your computer, read the safety information that shipped with your computer and follow the steps in "Before You Begin" on page 9. After working inside your computer, follow the instructions in "After Working Inside Your Computer" on page 11. For additional safety best practices information, see the Regulatory Compliance Homepage at [dell.com/regulatory\\_compliance](http://dell.com/regulatory_compliance).

## Procedure

- 1 Connect the display cable to the display-panel connector.
- 2 Adhere the tape that secures the display cable.
- 3 Gently place the display panel on the display back cover and align the screw holes on the display panel with the screw holes on the display back-cover.
- 4 Replace the screws that secure the display panel to the display back-cover.

## Postrequisites

- 1 Replace the display hinges. See "Replacing the Display Hinges" on page 64.
- 2 Replace the display bezel. See "Replacing the Display Bezel" on page 61.
- 3 Replace the display assembly. See "Replacing the Display Assembly" on page 58.
- 4 Follow the instructions from step 3 to step 9 in "Replacing the System Board" on page 49.
- 5 Replace the palm-rest. See "Replacing the Palm-Rest" on page 35.
- 6 Replace the keyboard. See "Replacing the Keyboard" on page 20.
- 7 Replace the wireless Mini-Card. See "Replacing the Wireless Mini-Card" on page 30.
- 8 Follow the instructions from step 3 to step 5 in "Replacing the Hard Drive" on page 27.
- 9 Replace the memory module(s). See "Replacing the Memory Module(s)" on page 24.
- 10 Replace the base cover. See "Replacing the Base Cover" on page 22.
- 11 Follow the instructions from step 3 to step 4 in "Replacing the Optical Drive" on page 16.
- 12 Replace the battery. See "Replacing the Battery" on page 13.

# Removing the Camera Module

---



**WARNING:** Before working inside your computer, read the safety information that shipped with your computer and follow the steps in "Before You Begin" on page 9. After working inside your computer, follow the instructions in "After Working Inside Your Computer" on page 11. For additional safety best practices information, see the Regulatory Compliance Homepage at [dell.com/regulatory\\_compliance](http://dell.com/regulatory_compliance).

## Prerequisites

- 1 Remove the battery. See "Removing the Battery" on page 12.
- 2 Follow the instructions from step 1 to step 2 in "Removing the Optical Drive" on page 14.
- 3 Remove the base cover. See "Removing the Base Cover" on page 21.
- 4 Remove the memory module(s). See "Removing the Memory Module(s)" on page 23.
- 5 Follow the instructions from step 1 to step 3 in "Removing the Hard Drive" on page 25.
- 6 Remove the wireless Mini-Card. See "Removing the Wireless Mini-Card" on page 28.
- 7 Remove the keyboard. See "Removing the Keyboard" on page 17.
- 8 Remove the palm-rest. See "Removing the Palm-Rest" on page 31.
- 9 Follow the instructions from step 1 to step 8 in "Removing the System Board" on page 46.
- 10 Remove the display assembly. See "Removing the Display Assembly" on page 56.
- 11 Remove the display bezel. See "Removing the Display Bezel" on page 59.

# Procedure

- 1 Peel the tapes that secure the camera module to the display back-cover.
- 2 Disconnect the camera cable from the camera module.
- 3 Peel the camera module off the display back-cover.

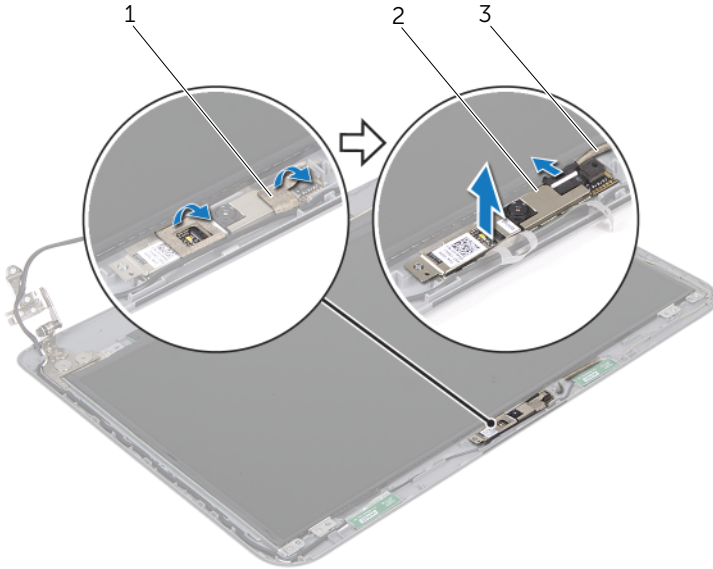

1	tapes (2)	2	camera module
3	camera cable		

# Replacing the Camera Module

---



**WARNING:** Before working inside your computer, read the safety information that shipped with your computer and follow the steps in "Before You Begin" on page 9. After working inside your computer, follow the instructions in "After Working Inside Your Computer" on page 11. For additional safety best practices information, see the Regulatory Compliance Homepage at [dell.com/regulatory\\_compliance](http://dell.com/regulatory_compliance).

## Procedure

- 1 Adhere the camera module to the display back-cover.
- 2 Connect the camera cable to the camera-module connector.
- 3 Adhere the tapes that secure the camera module to the display back-cover.

## Postrequisites

- 1 Replace the display bezel. See "Replacing the Display Bezel" on page 61.
- 2 Replace the display assembly. See "Replacing the Display Assembly" on page 58.
- 3 Follow the instructions from step 3 to step 9 in "Replacing the System Board" on page 49.
- 4 Replace the palm-rest. See "Replacing the Palm-Rest" on page 35.
- 5 Replace the keyboard. See "Replacing the Keyboard" on page 20.
- 6 Replace the wireless Mini-Card. See "Replacing the Wireless Mini-Card" on page 30.
- 7 Follow the instructions from step 3 to step 5 in "Replacing the Hard Drive" on page 27.
- 8 Replace the memory module(s). See "Replacing the Memory Module(s)" on page 24.
- 9 Replace the base cover. See "Replacing the Base Cover" on page 22.
- 10 Follow the instructions from step 3 to step 4 in "Replacing the Optical Drive" on page 16.
- 11 Replace the battery. See "Replacing the Battery" on page 13.

# Flashing the BIOS

---

The BIOS may require flashing when an update is available or when replacing the system board. To flash the BIOS:

- 1 Turn on the computer.
- 2 Go to **dell.com/support**.
- 3 Click **Start Here** under **Support for Home Users**.
- 4 If you have your computer's Service Tag, type your computer's Service Tag and click **Submit**.

If you do not have your computer's service tag, click **Detect Service Tag** to allow automatic detection of your computer's service tag.



**NOTE:** If the Service Tag cannot be detected automatically, select your product under the product categories.

- 5 Click **Drivers & Downloads** tab.
- 6 In the **Operating System** drop-down, select the operating system installed on your computer.
- 7 Click **BIOS**.
- 8 Click **Download File** to download the latest version of the BIOS for your computer.
- 9 On the next page, select **Single-file download** and click **Continue**.
- 10 Save the file and once the download is complete, navigate to the folder where you saved the BIOS update file.
- 11 Double-click the BIOS update file icon and follow the instructions on the screen.